



**BBQ MSRP
PRICE LIST**
J5 BI 5 FM202&



Redman Distributing Inc.
395 Dobbie Drive
Cambridge ON
N1T 1S8

Call Centre

Purchase order submission, Product availability / Stock check, Order status

Phone: 888.340.4949

Email: gUYg@redmandistributing.com

www.alfrescogrills.com

*SIZE indicated is considered nominal width of the unit.

BARBEQUE GRILLS

All products come NATURAL GAS. For LIQUID PROPANE, please indicate with a "-LP" (e.g. ALXE-30-LP)

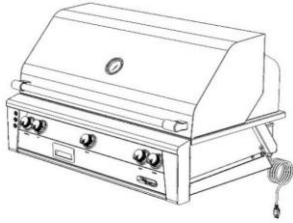

ALXE ► BUILT-IN GRILLS				
MODEL	SIZE	DESCRIPTION	GAS TYPE	MSRP
ALXE-30	30"	30" Standard Grill Head, 542 sq.in. grill surface, 2 Burner	NATURAL	\$6, JJJ
ALXE-30SZ		30" SearZone™ Grill Head, 542 sq.in. grill surface, 1 Burner + 1 Sear Burner	NATURAL	\$ĭ ,GJJ
ALXE-36	36"	36" Standard Grill Head, 660 sq.in. grill surface, 3 Burner	NATURAL	\$ĭ ,9JJ
ALXE-36SZ		36" SearZone™ Grill Head, 660 sq.in. grill surface, 2 Burner + 1 Sear Burner	NATURAL	\$J ,GJ9
ALXE-42	42"	42" Standard Grill Head, 770 sq.in. grill surface, 3 Burner	NATURAL	\$J ,6J9
ALXE-42SZ		42" SearZone™ Grill Head, 770 sq.in. grill surface, 2 Burner + 1 Sear Burner	NATURAL	\$9 ,ĭ JJ
ALXE-42SZ-LP		42" SearZone™ Grill Head, 770 sq.in. grill surface, 2 Burner + 1 Sear Burner, LP	LP	\$9 ,ĭ JJ
ALXE-56	42" grill area + 14" side burner	56" Standard GrillHead w/Sideburner, 770 sq.in. grill surface, 3 Burner + 20k BTU Sideburner	NATURAL	\$1F ,JJJ
ALXE-56SZ		56" SearZone™ Grill Head w/Sideburner, 770 sq.in. grill surface, 2 Burner + 1 Sear Burner + 20k BTU Sideburner	NATURAL	\$1G ,JJJ
ALXE-56BFG	56"	56" Standard All Grill Head, 998 sq.in. grill surface, 3 Burner + 1 Sear Burner	NATURAL	\$1Hĭ , JJ

42" Grill **PLUS** attached 20k BTU

* All Grills with a Serial # starting with "18-" have hood bumper modifications

All products come NATURAL GAS. For LIQUID PROPANE, please indicate with a "-LP" (e.g. ALXE-30C-LP)

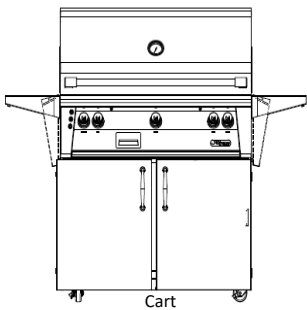

Cart

ALXE ► GRILLS ON CART				
MODEL	SIZE	DESCRIPTION	GAS TYPE	MSRP
ALXE-30C	30"	30" Standard Grill and Cart, 542 sq.in. grill surface, 2 Burner		\$7, JJJ
ALXE-30C-LP		30" Standard Grill and Cart, 542 sq.in. grill surface, 2 Burner, LP		\$7, JJJ
ALXE-30SZC		30" SearZone™ Grill and Cart, 542 sq.in. grill surface, 1 Burner + 1 Sear Burner		\$ĭ ,GJJ
ALXE-36C	36"	36" Standard Grill and Cart, 660 sq.in. grill surface, 3 Burner		\$1F ,ĭ JJ
ALXE-36SZC		36" SearZone™ Grill and Cart, 660 sq.in. grill surface, 2 Burner + 1 Sear Burner		\$1F ,ĭ JJ
ALXE-42C	42"	42" Standard Grill and Cart, 770 sq.in. grill surface, 3 Burner		\$1Gĭ , JJ
ALXE-42CD		42" Standard Grill and Deluxe Cart, 770 sq.in. grill surface, 3 Burner		\$1G ,JJJ
ALXE-42SZC		42" SearZone™ Grill and Cart, 770 sq.in. grill surface, 2 Burner + 1 Sear Burner		\$1Gĭ , JJ
ALXE-42SZCD		42" SearZone™ Grill and Deluxe Cart, 770 sq.in. grill surface, 2 Burner + 1 Sear Burner		\$1H ,GJJ
ALXE-56C	42" grill area + 14" side burner	56" Standard Grill w/Sideburner and Deluxe Cart, 770 sq.in. grill surface, 3 Burner + 20k BTU Sideburner		\$1ĭ ,ĭ JJ
ALXE-56SZC		56" SearZone™ Grill w/Sideburner and Deluxe Cart, 770 sq.in. grill surface, 2 Burner + 1 Sear Burner + 20k BTU Sideburner		\$1ĭ ,ĭ JJ
ALXE-56BFGC	56"	56" Standard All Grill and Deluxe Cart, 998 sq.in. grill surface, 3 Burner + 1 Sear Burner		\$1ĭ ,ĭ JJ

Deluxe Cart

42" Grill **PLUS** attached 20k BTU Sideburner

* All Grills with a Serial # starting with "18-" have hood bumper modifications

BARBEQUE GRILLS continues

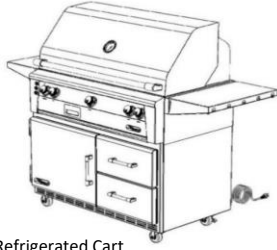

Refrigerated Cart

42" Grill **PLUS** attached 20k BTU Sideburner

All products come NATURAL GAS. For LIQUID PROPANE, please indicate with a "-LP" (e.g. ALXE-42R-LP)

ALXE ► GRILLS ON REFRIGERATED BASES				
MODEL	SIZE	DESCRIPTION		MSRP
ALXE-42R	42"	42" Standard Grill and Refrigerated Cart, 770 sq.in. grill surface, 3 Burner		\$1J, JJJ
ALXE-42SZR		42" SearZone™ Grill and Refrigerated Cart, 770 sq.in. grill surface, 2 Burner + 1 Sear Burner		\$1J, JJJ
ALXE-56R	42" grill area + 14" side burner	56" Standard Grill w/Sideburner and Refrigerated Cart, 770 sq.in. grill surface, 3 Burner + 20k BTU Sideburner		\$2G, JJJ
ALXE-56SZR		56" SearZone™ Grill w/Sideburner and Refrigerated Cart, 770 sq.in. grill surface, 2 Burner + 1 Sear Burner + 20k BTU Sideburner		\$2G, JJJ
ALXE-56BFGR	56"	56" Standard All Grill and Refrigerated Cart, 998 sq.in. grill surface, 3 Burner + 1 Sear Burner		\$2I, JJJ

* All Grills with a Serial # starting with "18-" have hood bumper modifications

*****A vinyl cover is included in each grill package.*****

PIZZA OVENS

All products come NATURAL GAS. For LIQUID PROPANE, please indicate with a "-LP" (e.g. AXE-PZA-LP)

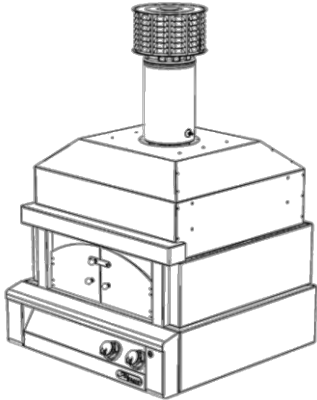

ALF-PZA-BI (Built-in).

PIZZA OVENS				
MODEL	SIZE	DESCRIPTION		MSRP
AXE-PZA	30"	Pizza Oven for Countertop Mounting		\$9, JJJ
AXE-PZA-BI		Pizza Oven for Built-in Installations		\$10, JJJ
AXE-PZA-CART		Basic Pizza Oven Cart		\$GFI J
AXE-PZA-PPC		Deluxe Pizza Prep Cart		\$I, I J
AXE-PZA-PEEL	~	Pizza Peel		\$1FJ
AXE-PZA-GD-KIT	~	Glass Door Conversion Kit		\$6I J

* All Pizza Ovens with a Serial # Starting with "18-" have Glass Doors & other enhancements

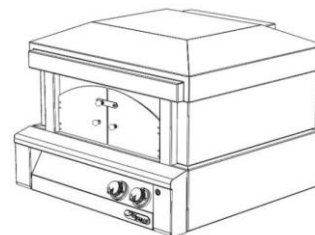

ALF-PZA (Countertop)

GRILL ACCESSORIES

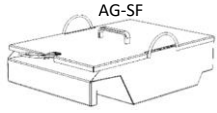

GRILL ACCESSORIES			
MODEL	DESCRIPTION		MSRP
AGSQ-G	Griddle For Grill Mounting		\$5JJ
AG-SF	Grill mounted Steamer / Fryer		\$J7J
AIC-POD	Indirect Cooking Pod		\$5JJ
SFI-POD	Solid Fuel Insert		\$9JJ
XE-36AG	36" Grill Accessory Grate - use with 36" Grill plus any of above acc.		\$JJ

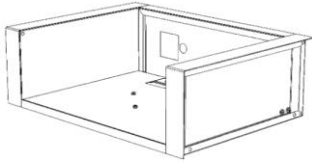

INSULATING JACKETS			
MODEL	SIZE	DESCRIPTION	MSRP
AIJ-30	30"	30" Insulating jackets for all ALXE 30" grill Heads	\$1,FJJ
AIJ-36	36"	36" Insulating jackets for all ALXE 36" grill Heads	\$1,G J
AIJ-42	42"	42" Insulating jackets for all ALXE 42" grill Heads	\$1,GJJ
AIJ-56	56"	56" Insulating jackets for all ALXE 56" grill Heads	\$1,HJJ

WIND GUARDS			
MODEL	SIZE	DESCRIPTION	MSRP
AWS-30	30"	30" Wind Guard	\$5i i
AWS-36	36"	36" Wind Guard	\$i i G
AWS-42	42"	42" Wind Guard	\$i H i
AWS-56	56"	56" Wind Guard	\$i i €

WIND GUARDS FOR CARTS			
MODEL	SIZE	DESCRIPTION	MSRP
AWS-30C	30"	30" Wind Guard for Cart Grill	\$6JJ
AWS-36C	36"	36" Wind Guard for Cart Grill	\$i i J
AWS-42C	42"	42" Wind Guard for Cart Grill	\$i JJ
AWS-56C	56"	56" Wind Guard for Cart Grill	\$JJJ



Deluxe

CARTS ONLY			
MODEL	SIZE	DESCRIPTION	MSRP
XE-30C	30"	Standard Cart	\$2,i i i
XE-36C	36"	Standard Cart	\$H i G
XE-42C	42"	Standard Cart	\$3,i i i
XE-42CD		Deluxe Cart (shown left)	\$3,J i €
XE-56C	56"	Deluxe Cart	\$i ,i €G

All products come NATURAL GAS. For LIQUID PROPANE, please indicate with a "-LP" (e.g. ALXESB-2-LP)

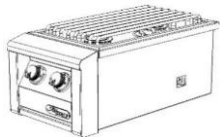

SIDE BURNERS			
MODEL	SIZE	DESCRIPTION	MSRP
AXESB-2	14"	14" Built-in 2 Burner Unit, NG	\$G€JJ
AXESB-2C		2 Burner Unit for Cart Mount, NG	\$2,i i J
AXESZ		14" Built-in SearZone™ Unit, NG	\$2,i JJ

* All Side Burner Units with a Serial # starting with "18-" have 110 VAC Ignition System & "Control Knob Accent Lights"

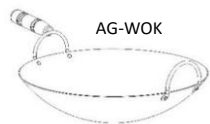

AG-WOK

SIDE BURNER ACCESSORIES			
MODEL	DESCRIPTION		MSRP
AG-WR	Wok Ring Adaptor		\$GJ
AG-WOK	Commercial Wok 14" Ø with Handle		\$2i J
AGSB-G	Griddle for Side Burner		\$i JJ

VERSAPOWER™ COOKING SYSTEM

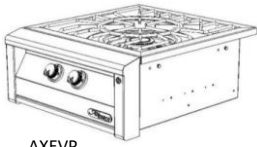

AXEVP



AXEPT-TG



AXEPT-WOK

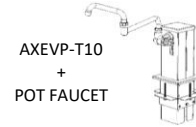

AXEVP-T10
+
POT FAUCET

All products come NATURAL GAS. For LIQUID PROPANE, please indicate with a "LP" (e.g. ALXEVP-LP)

VERSAPOWER™ COOKING SYSTEM				
MODEL	SIZE	DESCRIPTION		MSRP
AXEVP	24"	VersaPower™ Cooker		\$HGĜ
AXEVP-C	24"	Cart for VersaPower™ Cooker		\$1,ĭĭJ
AXEVP-COUNTER *	42"	AXEVP - all stainless - counter with storage		\$5,JĭG
AXEVP-LP TANK	14"	LP Tank attachment for AXEVP-Counter		\$ĭGJ
AXEVP-TG	19"	Teppanyaki Griddle for VersaPower™ Cooker		\$1,GJJ
AXEVP-WOK	22"	Commercial Wok 22" Ø		\$2JJ
AXEVP-T10	14"	Pot Filler Tower 10" ~ 14" adjustable		\$1,ĭĭJ
POT FAUCET	~	Pot Filler Faucet w/double joint spout		\$ĭĭJ

* All VersaPower Units with a Serial # starting with "18-" have 110 VAC Ignition System & "Control Knob Accent Lights"

* AXEVP-Counter includes AXE-30DR-SC listed under Island accessories. AXEVP Unit shown is not included.



AXEVP-COUNTER

REFRIGERATION

ARXE-42

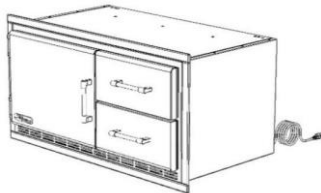

URS-

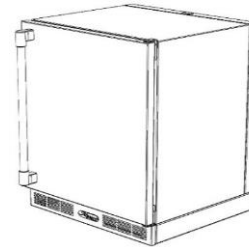

AKK

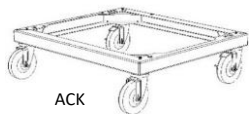

ACK

REFRIGERATION				
MODEL	SIZE	DESCRIPTION		MSRP
ARXE-42	42"	42" Built-In Refrigerator		\$9,JJJ
ARXE-42C		42" Refrigerator (mounted on 42" BBQ Cart)		\$10,JJJ
ARXE-56C	56"	56" Refrigerator (mounted on 56" BBQ Cart)		\$1F,ĭĭJ
URS-1XE	28"	One Door Refrigerator (for Kegeator will need AKK-USA)		\$ĭ,ĭJJ

REFRIGERATION ACCESSORIES				
MODEL		DESCRIPTION		MSRP
AKK		URS-1XE Keg Kit		\$1,ĭJJ
ACK		URS-1 Caster Kit		\$ĭĭJ

ISLAND ACCESSORIES

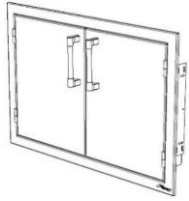

AXE30/36/42

ACCESS DOOR SHOWN SOLD SEPARATELY

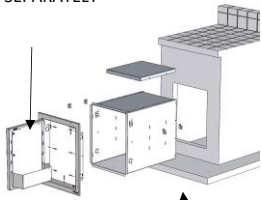

AXE-17/23/30/36/42E



AXE-3DR

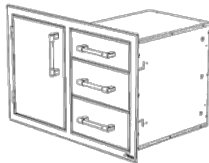

AXE-DDC-L



AXE-TC

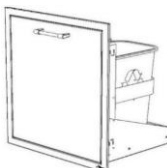

AXE-TC2D

ACCESS DOORS				
MODEL	SIZE	DESCRIPTION		MSRP
AXE-17L	17"	Single Access LEFT Door		\$4JJ
AXE-17R		Single Access RIGHT Door		\$4JJ
AXE-23L	23"	Single Access LEFT Door		\$1Ī J
AXE-23R		Single Access RIGHT Door		\$1Ī J
AXE-30	30"	Double Access Doors		\$1 HJ
AXE-36	36"	Double Access Doors		\$J I J
AXE-42	42"	Double Access Doors		\$JĪ J
XEDS-1	~	Accessory Door Bin for AXE-17		\$1FJ
XEDS-2	~	Accessory Door Bin for AXE-23		\$1FJ
XEDS-1*	~	Accessory Door Bin for AXE-30 (2 required)		\$1FJ
XEDS-3*	~	Accessory Door Bin for AXE-36 (2 required)		\$1FJ
XEDS-2*	~	Accessory Door Bin for AXE-42 (2 required)		\$1FJ

Running Change on All Doors they will be "Doubled Wall Construction"

**Double Sided Access Doors 30 inches or large will require 2 Accessory Door bins to be ordered*

ISLAND ACCESS DOOR ENCLOSURES				
MODEL	SIZE	DESCRIPTION		MSRP
AXE-17E	17"	17" Island Access Door Enclosures		\$6JJ
AXE-23E	23"	23" Island Access Door Enclosures		\$JJJ
AXE-30E	30"	30" Island Access Door Enclosures		\$1,FJJ
AXE-36E	36"	36" Island Access Door Enclosures		\$1,H J
AXE-42E	42"	42" Island Access Door Enclosures		\$1,I I J

STORAGE DRAWERS				
MODEL	SIZE	DESCRIPTION		MSRP
AXE-2DR-SC	17"	Two Tier Storage Drawers		\$1,I JJ
AXE-3DR-SC	17"	Three Tier Storage Drawers		\$1,Ī Ī J
AXE-30DR-SC	30"	VersaPower™ Accessory Drawer		\$1,Ī JJ

** All Drawer units with a "-SC" have "Soft Close" Drawer Slides*

DOOR & DRAWERS COMBOS				
MODEL	SIZE	DESCRIPTION		MSRP
AXE-DDC-L-SC	32"	Three Drawers w/ Door on LEFT		\$GĒ Ī J
AXE-DDC-R-SC		Three Drawers w/ Door on RIGHT		\$GĒ Ī J
AXE-DDR-L-SC	17"	One Drawer W/ Door Open Left		\$1,H J
AXE-DDR-R-SC		One Drawer W/ Door Open Right		\$1,H J
AXE-DTH-L-SC		Paper Towel Holder W/ Door Open Left		\$FĒ FJ
AXE-DTH-R-SC		Paper Towel Holder W/ Door Open Right		\$FĒ FJ
AXE-3DRTH-SC		Paper Towel Holder W/ Three Drawers		\$2Ē FJ
XEDS-1		~	Accessory Door Bin for DDC-SC-USA Combo Units	
XEDS-4	~	Accessory Door Bin for DDR-SC-USA Combo Units		\$1FJ
XEDS-4	~	Accessory Door Bin for DTH-USA Combo Units		\$1FJ

** All Door & Drawer units with a "-SC" have "Soft Close" Drawer Slides and Double Wall Door Construction*

TRASH CENTERS & ACCESSORIES				
MODEL	SIZE	DESCRIPTION		MSRP
AXE-TC-SC	15"	Trash Center Drawer		\$1,H €
AXE-TC2D-SC	19-5/8"	Dual Trash Center / Recycling Drawer (Deep)		\$1,Ī JJ
AXE-TH	17"	Paper Towel Holder		\$Ī Ī
APWC	10"	Prep & Waste Chute Assembly		\$5Ī F

** All Trash Center units with a "-SC" have "Soft Close" Drawer Slides*

ISLAND ACCESSORIES continued

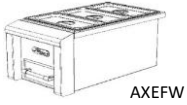

AXEFW

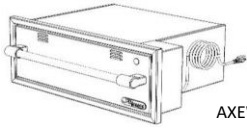

AXEWD-30

FOOD WARMERS			
MODEL	SIZE	DESCRIPTION	MSRP
AXEFW	14"	Built-in Food Warmer	\$1,1 J J
AXEFCW	14"	Cart Mount Food Warmer	\$66 G J
AXEWD-30	30"	Warming Drawer - 110 VAC Powered	\$H F I J



AXEDSP-30L

DRY STORAGE PANTRIES			
MODEL	SIZE	DESCRIPTION	MSRP
AXEDSP-30L	30"	Low Profile Unit (21" high)	\$H 6 J
AXEDSP-30H		High Profile Unit (33" high)	\$3,1 6 J
AXEDSP-36L	36"	Low Profile Unit (21" high)	\$3,1 I G
AXEDSP-42L	42"	Low Profile Unit (21" high)	\$3,1 J I
AXEDSP-42H		High Profile Unit (33" high)	\$I, H 6



APS-30P

GARNISH RAIL AND PLATING STATION			
MODEL	SIZE	DESCRIPTION	MSRP
APS-30P	30"	30" Plate & Garnish Rail w/ Food Pans	\$2,1 J J
APS-30PPC		30" Pizza Prep & Garnish Rail w/ Food Pans	\$H F J J

BEVERAGE CENTERS AND VERSA SINK SYSTEMS

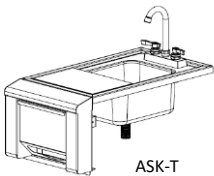

ASK-T

PREP & HAND WASH SINK			
MODEL	SIZE	DESCRIPTION	MSRP
ASK-T	14"	Prep / Hand Wash Sink - includes: Hot and Cold Water Faucet, Cutting Board, Paper Towel Holder	\$1, J J J
RAIL-14	14"	Speed Rail - 14"	\$2 I J
RAIL-19	19"	Speed Rail - 19"	\$2 J J



AXE-ID

UNDERCOUNTER INSULATED ICE-DRAWER			
MODEL	SIZE	DESCRIPTION	MSRP
AXE-ID	26"	Undercounter Ice-Drawer - Insulated - Includes: 4 Condiment Bowls, SS Ice Pan, Bottle Spacer, Condiment Tray Holder, Spacer Bar	\$H G I

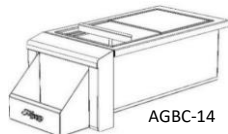

AGBC-14

VERSA SINKS			
MODEL	SIZE	DESCRIPTION	MSRP
AGBC-14	14"	Versa Sink Bartender & Sink System ①	\$1,1 H J
AGBC-24	24"	Versa Sink Bartender & Sink System ②	\$2, H J J



AGBC-24

- ① = Includes: 10" wide Speed Rail and Sliding Ice Cover
- ② = Includes: 14" wide Speed Rail, Bottle Opener, 4-Bottle Wells w/ Holder Tray and Sliding Ice Cover

VERSA SINK SYSTEMS



AGBC-30 (MAIN SINK)

VERSA-SINK SYSTEM				
MODEL	SIZE	DESCRIPTION		MSRP
AGBC-30		Main Versa Sink System		\$GF J
SINK PACKAGE	30"	Preparation package for 30" sink ③		\$J J
BAR PACKAGE		Bartending package for 30" sink ④		\$1,1 J

③ = Includes: 4" deep Perforated Colander, Wood Cutting Board, Speed Rail and Towel Holder
 ④ = Includes: 6" deep Ice Pan, Cutting Board, Speed Rail, 4 Bottle Wells, Blender Shelf, Bottle Opener with Bottle Cap Catch-Can and Towel Holder.

AGBC-30 W / SINK PKG.

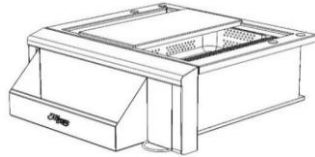

AGBC-30 W / BAR PKG.

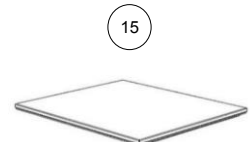
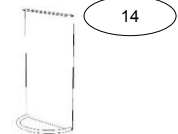
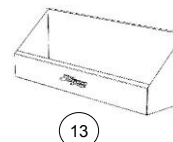
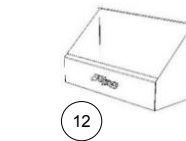
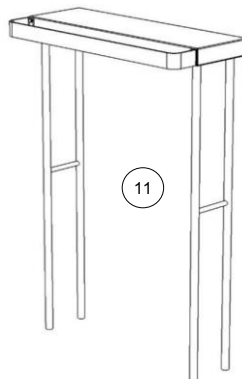
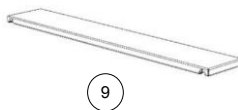
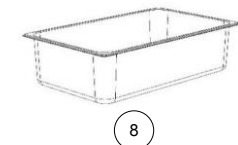
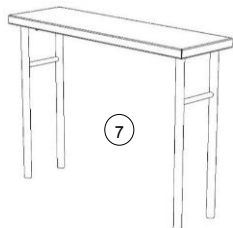
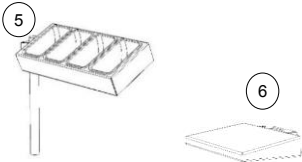
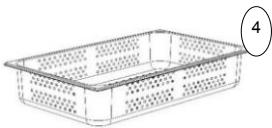
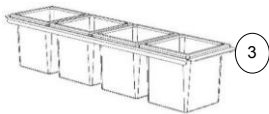
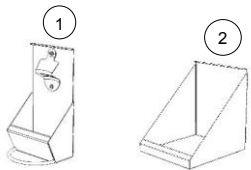
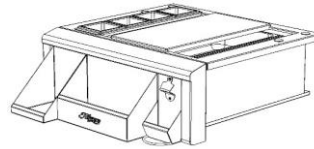

VERSA SINK SYSTEM ACCESSORIES				
MODEL	#	DESCRIPTION		MSRP
BO	1	Bottle Opener w/ Cap Catch & Towel Rack		\$G ĩ
BS	2	Blender Shelf		\$2 ĩ
BWELL	3	4 Bottle Wells w/ Holder Tray		\$1 JH
COLANDER	4	Stainless Steel Colander - 4" Deep		\$ĭ ĩ
CT	5	Condiment Tray		\$2 Ğ
DS	6	Display Shelf		\$ĭ ĩ
HS-30	7	Serving Shelf w/ Light (for AGBC-30)		\$J J
ICE PAN	8	Ice Pan - 6" deep -Stainless Steel		\$ĭ ĩ
MS	9	Middle Shelf (HS-30 or PR-30 required)		\$178
PANTRY FAUCET	10	Commercial Dual Supply Pantry Faucet.		\$880
PR-30	11	High Shelf w/ Pot Rack & Light (for AGBC-30)		\$1,232
SPR-LG	12	Speed Rail - Large		\$662
SPR-SM	13	Speed Rail - Small		\$532
TH	14	Towel Holder		\$178
SC-30	15	Versa Sink S/S Cover (for AGBC-30)		\$457

VINYL COVERS FOR GRILLS AND ACCESSORIES



VINYL COVERS				
MODEL	SIZE	DESCRIPTION		MSRP
AGV-30	30"	30" Cover for Built-In Grills		\$169
AGV-30C		30" Cover for Cart Models		\$179
NEW AGV-30CSB		30" Cover for Cart Models W/ Side Burner		\$179
AGV-36	36"	36" Cover for Built-In Grills		\$179
AGV-36C		36" Cover for Cart Models		\$189
NEW AGV-36CSB		36" Cover for Cart Models W/ Side Burner		\$199
AGV-42	42"	42" Cover for Built-In Grills		\$199
AGV-42C		42" Cover for Cart Models		\$199
NEW AGV-42CSB		42" Cover for Cart Models W/ Side Burner		\$199
AGV-56	56"	56" Cover for Built-In Grills		\$199
AGV-56C		56" Cover for Cart Models		\$219
AGV-56BFG		56" Cover for Built-In Grills for ALXE-56BFG_		\$199
AGV-56BFGC		56" Cover for Cart Models		\$219
NEW AGV-PZA	~	Cover for Freestanding Pizza Oven		\$219
AVDT-30	30"	For 30" Beverage Center ADT-30		\$219

*****A vinyl cover is included in each grill package.*****